



**HALLA** A LANDMARK COMPANY FOR ENERGY,  
THE ENVIRONMENT, AND INDUSTRIAL PLANTS

## Contents

05	<b>CEO Remarks</b>
06	<b>Company Introduction</b>
07	<b>Business Areas</b>
08	<b>Environmental Plants</b>
10	• Waste Treatment Facilities
16	• Water Treatment Facilities
20	• Air Pollution Control Facilities
24	<b>Industrial Plants &amp; Equipment</b>
26	• Cement Plants
27	• Material handling, Loading & unloading Equipment
	• Ash Handling Systems
28	<b>Energy Plants</b>
30	• Renewable Energy Facilities
33	• Power Generation Facilities
34	<b>Civil Works and Building Engineering &amp; Construction</b>
38	<b>Other Business Areas</b>
40	• Operation & Maintenance of Facilities · CDM Projects
41	• Soil Remediation · ESCO Projects
42	<b>R&amp;D · Integrated Management System</b>

## A LANDMARK COMPANY FOR ENERGY, THE ENVIRONMENT, AND INDUSTRIAL PLANTS

**HALLA Energy & Environment** , in succession of Halla's half a century industrial plants business, had entered into the plant industry at its pioneer stage in Korea. Halla Energy & Environment has grown up to a largest specialized company in the environmental industry in Korea and leading company in industrial plants based on its advanced technology developed and plenty of experiences accumulated.

Based on its 40 years experience in the energy and environmental industry, Halla is now concentrating on the new and renewable energy industry such as wind power, solar energy and hydro power industry to substitute the fossil fuels to reduce CO<sub>2</sub> generation, a cause of global warming. Halla will be newly born to a total clean energy & environment industry.

Halla Energy & Environment has the capability to carry out all environmental and industrial plants, and civil & construction works on a turnkey basis ranging from feasibility studies to design, manufacturing, construction and operation & maintenance as well.

Halla Energy & Environment will be your trustworthy partner for your growth and success to offer you the most economical investment & operational costs and technical solutions as well in such fields of industrial & environmental plants, new & renewable energy facilities.

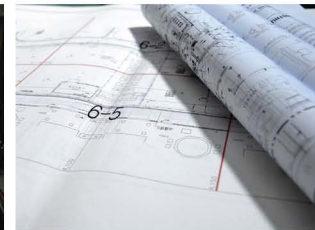





## CEO REMARKS

*The harmony of human beings and nature..... Under the corporate philosophy of “With Technology, We make the World where People and Nature harmonize each other”, Halla Energy & Environment entered into the environmental industry at its pioneer stage in Korea.*

*For more than 40 years since established, we have successfully completed a lot of environmental projects and developed and accumulated high technology in the fields of various waste treatment, waste water treatment, and air pollution control. Now, we have grown up to and been maintaining a reputation as a leading industry group in this fields.*

*Now, Halla Energy and Environment is newly born as a specialized E.P.C. supplier of total plants including new & renewable energy facilities in succession to Hyundai International Inc., and Halla Engineering & Heavy Industry who are regarded as a pioneer of plant industry in Korea.*

*We, Halla Energy & Environment, shall offer you the total solution for the economical initial investment and operation costs, environmental issues, and improving the plant’s efficiency. Halla is engaged in the wide range of service from the project feasibility study, engineering, manufacturing, supply, construction and operation & maintenance as well of various environmental and industrial plants.*

*We will always do our best efforts to satisfy and grow together with our clients through continuous development of the most environment friendly and competitive technology and service.*

## COMPANY INTRODUCTION

60~70's

- 1962** Established Hyundai International Inc., the predecessor of Halla Engineering & Heavy Industries Co. Ltd.
- 1978** Halla Heavy Industries entered the environmental industry field  
First company in Korea to be awarded an overseas contract to build a fabric collector facility (Saudi Arabia – Gizan Cement)

90's

- 1995** First Korean company to operate a municipal solid waste incineration plant (Changwon incineration plant)
- 1997** Received the Jang Yeong Shil Award for facility development in the field of anaerobic digestion utilizing organic waste to create compost
- 1999** Environmental division separated and became an independent company, Halla Energy & Environment  
Acquired patent for our anaerobic digestion facility used for organic waste treatment
- 2000** Received quality certifications for environmental facilities (electrostatic precipitator & flue gas desulfurization facilities)

2000's

- 2001** First company in Korea to acquire certification for an integrated management system (quality, the environment & health) in the areas of construction and the environment  
Completed construction of an industrial facility manufacturing plant in Eumseng, Korea  
Received quality certifications for environmental equipment (fabric collector)  
First company in Korea to be awarded a contract for flue gas denitrification facilities (Seoul thermal power plant)  
Founded GeoWorks specializing in soil remediation  
Received quality certificates for environmental equipment (Incineration facilities)
- 2002** Received Presidential Award at the New Technology Promotion Competition  
Received quality certification for an environmental facility (food waste recycling)
- 2003** Acquired equipment patent for the integrated digestive treatment of food waste & animal excrement  
Acquired patent for RID (Rotation Immersion Disks) system  
Acquired patent for HASS (Halla Advanced Sewage System)  
Acquired patent for soil remediation method (permeable reactive barrier)
- 2004** Acquired patent for gas sensor  
Acquired patent for RBF (Riverbed Filtration)  
Acquired patent for automated water treatment system  
Began R&D for solar energy applications  
Began R&D for the river bed filtration method  
Certified by the Korean Ministry of the Environment for new technology regarding water treatment method
- 2005** Established the Beijing office in China  
Received the \$3 million Export Tower Award  
Acquired new technology certificate (automated disinfection process in water treatment)  
Acquired patent for the pyrolysis & melting waste method
- 2006** Declared the '2010 Vision (HIT! 5010)'  
Acquired patent for manufacturing method of the sludge  
Acquired patent for intergrated incineration system for organic sludge and combustible waste  
Acquired patent for soil remediation technology  
Acquired 2<sup>nd</sup> patent for RBF
- 2007** Certified by the Korean Ministry of the Environment for new technology regarding RBF  
Acquired patent for industrial waste water recycling system  
Established the affiliated company Halla OMS specializing in facility operation and maintenance
- 2008** Completed construction of a steel wind tower & steel fabrication factory in Baria-Vungtau, Vietnam  
Established Indonesia office in Jakarta
- 2009** Established Saudi Arabia office in Al Khobar, Established Halla Energy & Environment(India)
- 2010** The 1<sup>st</sup> National Green Technology Award, Commendation of the Minister of Environment (Municipal Waste Recycling Plant, Pyrolysis & Melting Type)
- 2011** Excellence of Green Technology awarded, Seoul Environmental Awards
- 2012** Certificated for leading environmental company by Minister of Environment
- 2012** The Completion of the Korean's first Refused Derived Fuel (RDF) power plant (Iksan 2nd Industrial Complex Community Energy Supply System)
- 2015** Established the Baku office in the Republic of Azerbaijan

Present



## BUSINESS AREAS



## TURN-KEY BASIS ENGINEERING SOLUTION

“Based on our wide experiences, Halla Energy & Environment offers the total solution from feasibility studies to design, construction, operation and after sales service.”







# Environmental Plants

True coexistence between human beings and nature to create a better tomorrow...  
Halla Energy & Environment, Korea's largest environmental company is making it possible.





- **Waste Treatment Facilities**
- **Water Treatment Facilities**
- **Air Pollution Control Facilities**





## • Waste Treatment Facilities

**“Resource Recovery - Halla is at the Center of it!”**

Halla Energy & Environment, the company concentrating its efforts on human beings and the future value of the environment





# Municipal Solid Waste Incineration Plant

## Stoker / Stoker+Rotary Kiln

The waste incinerator of Halla Energy & Environment is the up-to-date technology with higher heat recovery from higher combustion efficiency and minimized generation of harmful substances such as dioxin, etc. Halla's incineration technology has been proven for its durability and safety through many plants that Halla has built and been operating as well. Halla's waste incinerator contributes to renewable power generating, too. Steam generated utilizing the waste heat from the incinerator is being sold for district heating and/or utilized to generate electric power by operating the steam turbine generator. The residual incineration ash generated from Halla's stoker and rotary kiln incinerator is being used to produce the bricks.

Ulsan municipal solid waste incineration plant (200 tons per day x2)

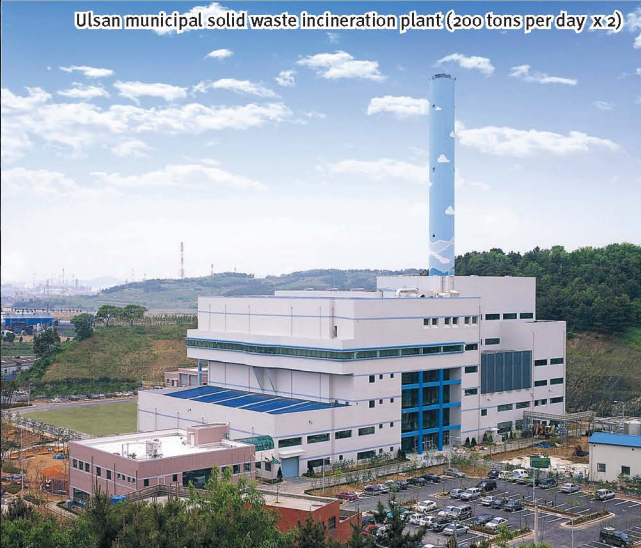

Mapo municipal solid waste incineration plant (250 tons per day x3)



Stoker

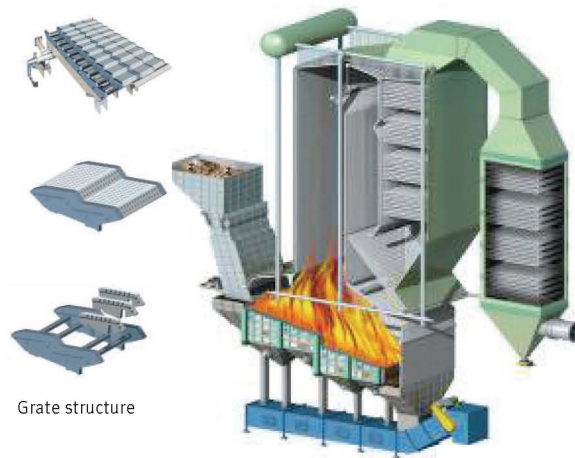

Stoker+Rotary Kiln

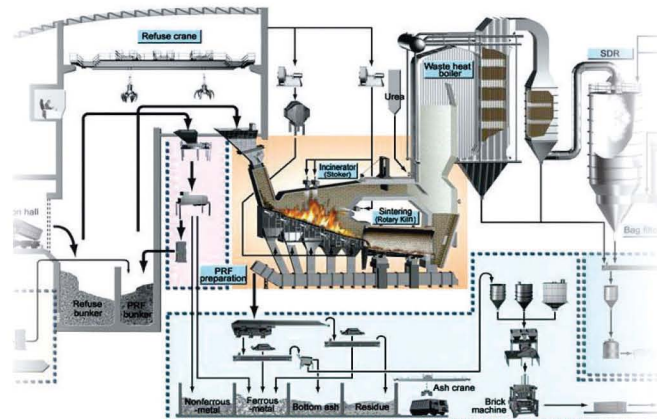

Inside of rotary kiln



## Pyrolysis, Gasification & Melting Incinerator (fluidized bed type)

The fluidized bed type pyrolysis, gasification & melting incinerator is an environment friendly and very stable technology in which the waste is partly burned by fluidized material and partly dissolved by the combustion heat, and the carbide generated is melted in the swirling - flow melting furnace by the gas combustion heat and discharged as slag.

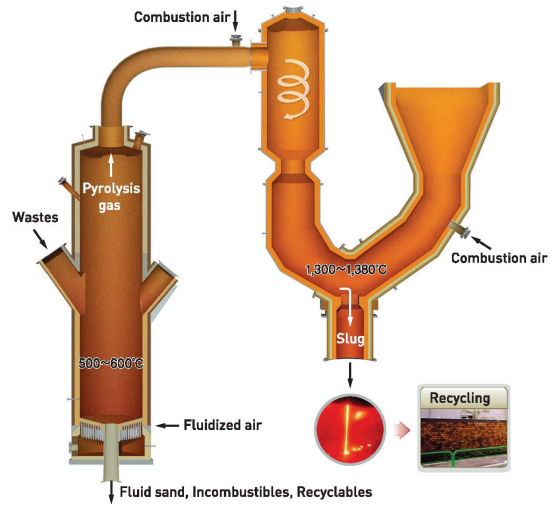
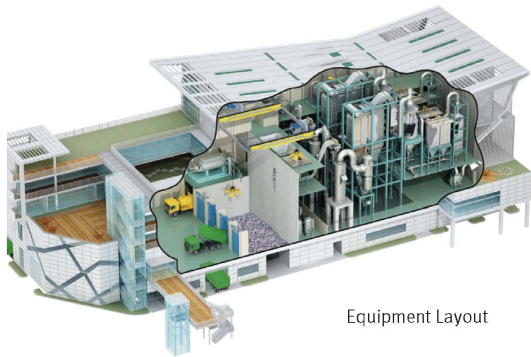

Pangyo Clean Tower Incinerator (45tons per day x 2)





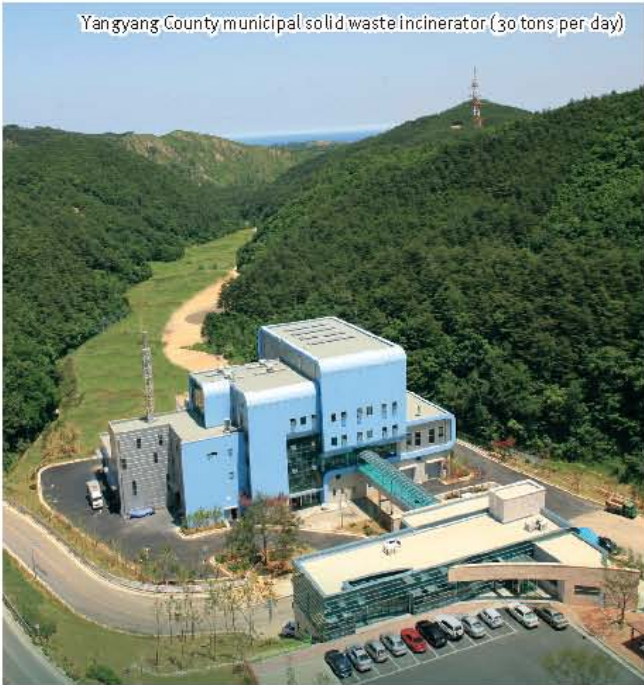

Yangyang County municipal solid waste incinerator (30 tons per day)

## Pyrolysis & Melting Stoker Incinerator

Halla's pyrolysis & melting stoker incinerator developed and commercialized by a domestic technology and patent allowed is the energy-saving system. It melts down the wastes utilizing high combustion heat of homogenized carbon material and pyrolyzes the residues utilizing combustible gas heat in the pyrolysis furnace of the incinerator. It is also an advanced technology that enables the recycling of solid residues through melting and vitrification and minimizes the dioxin emission.

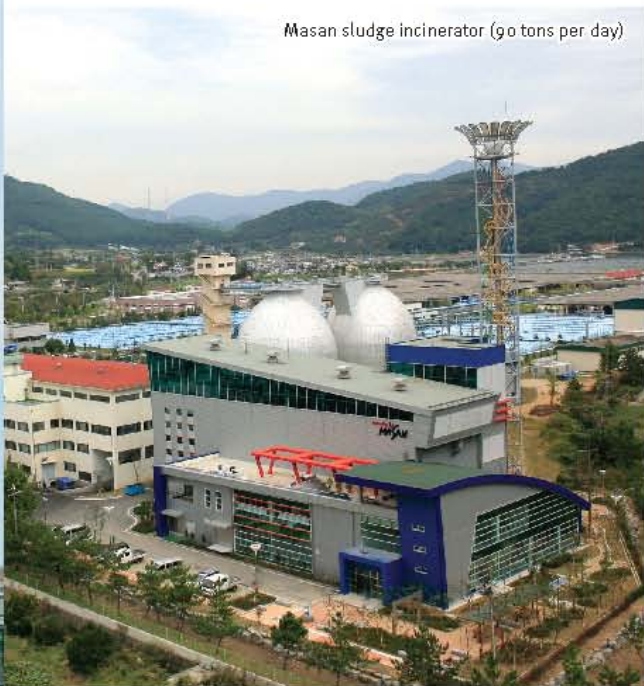
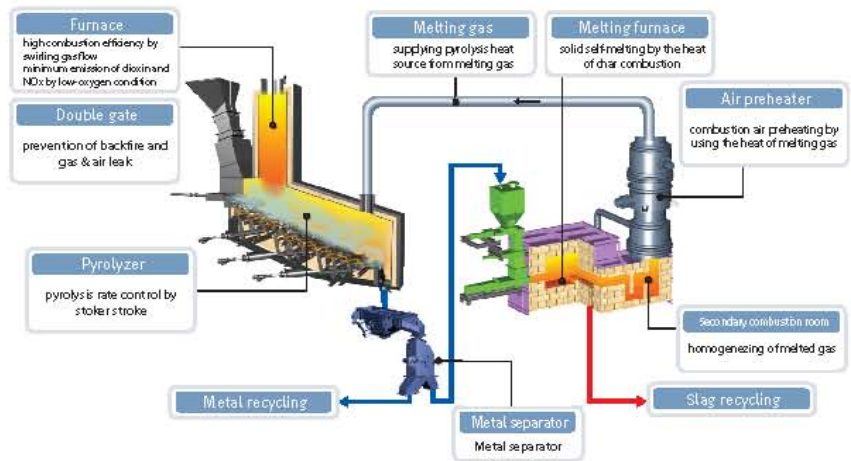

Masan sludge incinerator (90 tons per day)

## Sludge Incineration Facility (fluidized bed type)

Sludge generated at sewage water or wastewater treatment plants has different properties depending on the area, season and accordingly requires an optimally designed incineration system.

Halla Energy & Environment on the basis of our experience of having designed and installed one of the largest capacity pulp sludge incinerators in Korea (380 tons per day) is supplying optimal facilities suited for characteristics of the sludge itself.

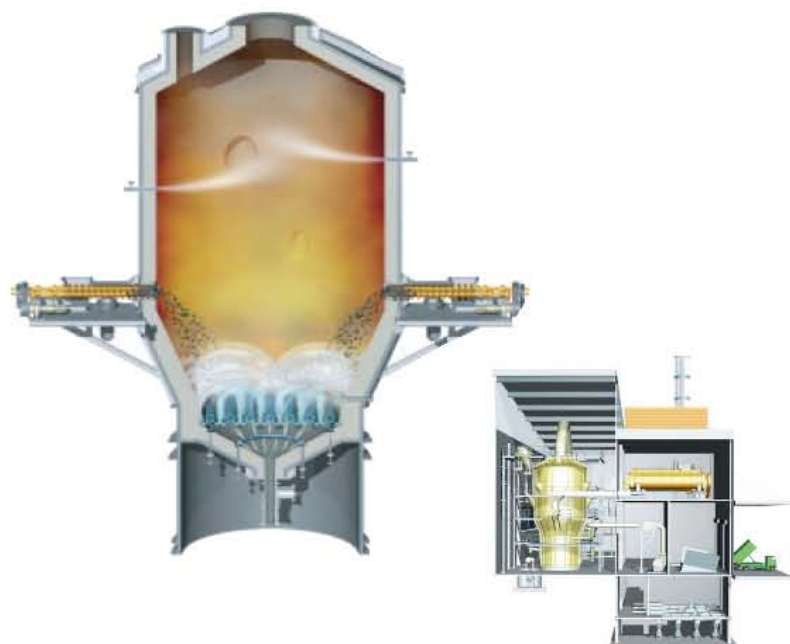





Clean Energy Center in the Hwasung-Dongtan area (45 tons per day)

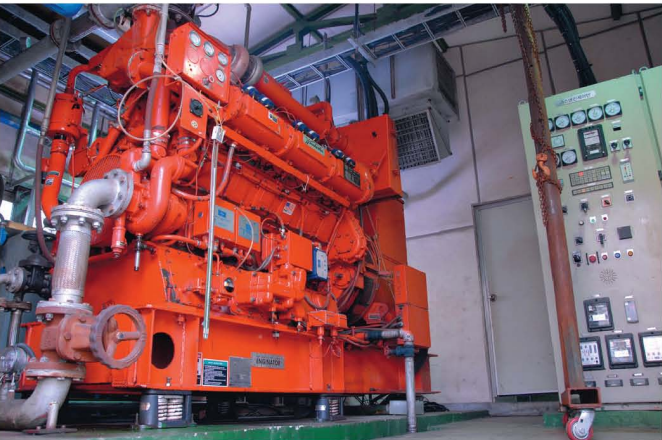

## Organic Waste Recycling Facility

Two-phase anaerobic digestion process for organic wastes recycling technology developed by Halla Energy & Environment can be used for biogas production not only through the anaerobic digestion of food waste with high sodium and water content, but also through various biodegradable organic waste like livestock manure, sewage sludge, etc. Sewage sludge, generated from the anaerobic digestion of organic waste is used as high quality compost or liquefied fertilizer and produces biogas as an alternative energy source for boilers and power generation facilities.

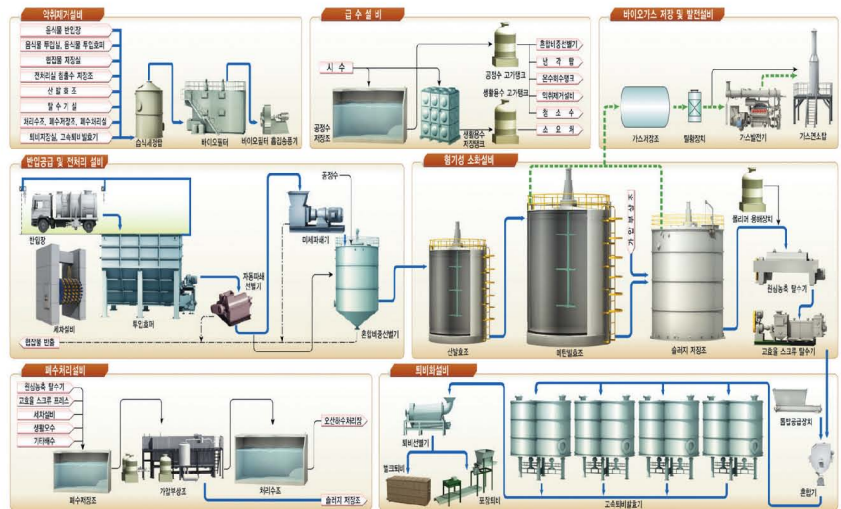

## Landfills

We construct sanitary and safe landfills for municipal solid waste and fly ash utilizing the anaerobic cell method, an advanced technology to minimize environmental pollution from secondary pollution substances.



Landfill site in Ulsan City (2,480,000m<sup>3</sup>)







Pangyo City Auto Clean Net

## Pneumatic Refuse Collection System

Waste is thrown into a hopper and transported through pipes using air vacuum and pressure to collection areas. Then the waste is separated and crushed or pressed so it can be easily transported to the 2<sup>nd</sup> stage or final stage treatment facility. This is an environment friendly technology that is excellent for use in downtown areas.

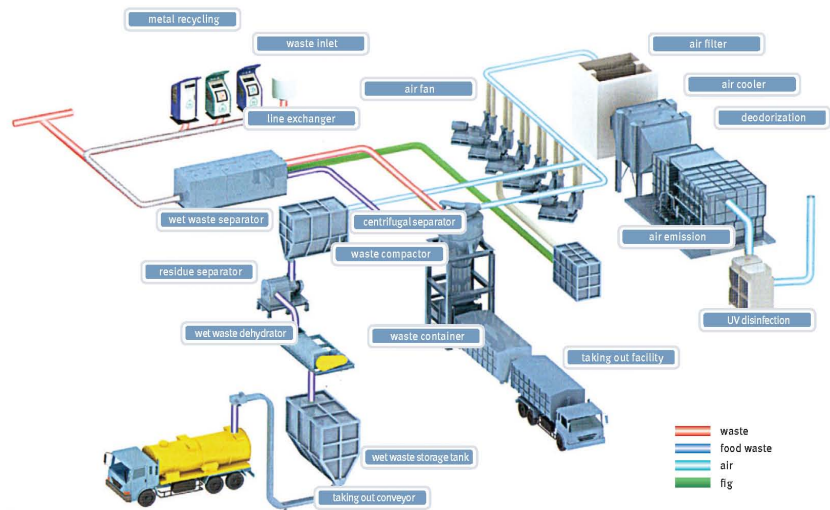

Automated Recycling Collection Facility

## Mechanical Biological Treatment

With MBT (Mechanical Biological Treatment) technology, the waste is separated mechanically before simple incineration or being taken to a landfill to collect the recyclable materials and to produce the RDF. This maximizes the amount of waste that can be turned into energy and minimizes the amount of waste that must be incinerated or taken to a landfill. The produced RDF can be used as an alternative fuel in cement production and power generation plants, and also the produced biogas can be used for power generation.

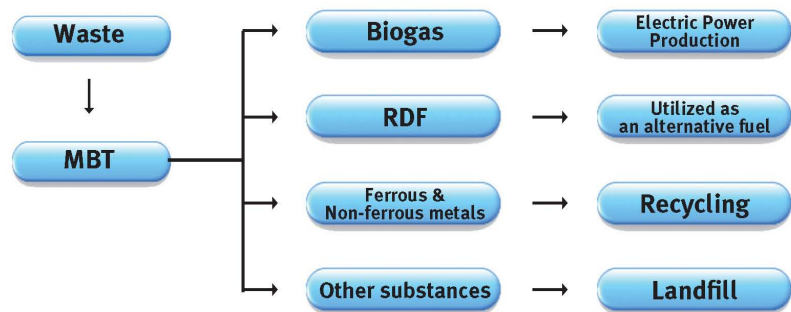

Fluff

Soft Pellet

Hard Pellet



- **Water Treatment Facilities**

**“Clean Water – Halla Energy & Environment can make it.”**

Halla Energy & Environment is insuring the stable supply of clean water for people.





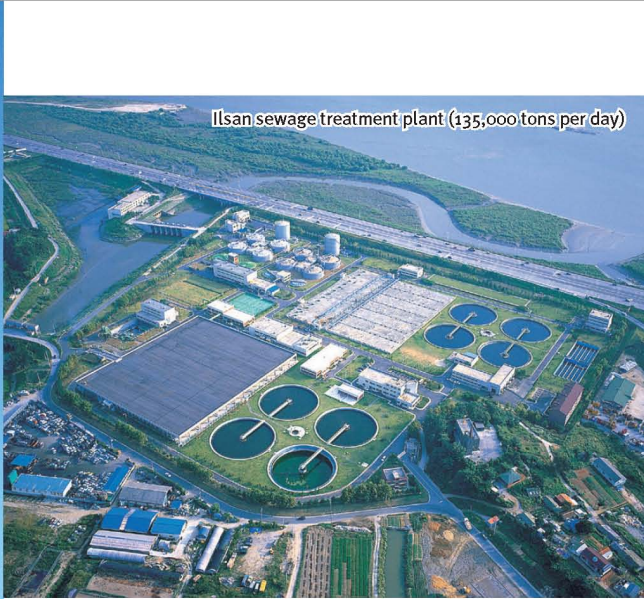

Ilsan sewage treatment plant (135,000 tons per day)

## Sewage Treatment

Water polluting is getting worse because of destruction of the natural environment and water ecosystems caused by rapid economic development and industrialization. Particularly, nitrogen and phosphorous are substances that destroy water ecosystems. Halla Energy & Environment has developed an advanced wastewater treatment process that can remove nitrogen and phosphorous and it can reduce eutrophication. We have built wastewater treatment plants near new urban areas and also environment friendly underground wastewater treatment plants for the reuse of recycled water.

### Underground sewage water treatment plant in suburban areas



Yangyang sewage treatment plant (9,000 tons per day)



Siheung-Neunggok sewage treatment plant (7,000 tons per day)



Yongin-Youngduk sewage treatment plant (13,000 tons per day)



Paju LCD industrial complex wastewater treatment plant (70,000 tons per day)

## Wastewater Treatment Plant

The characteristics of industrial wastewater can vary according to the substances contained and the production process. Therefore, it is important to perform a field study for an analysis of the pollution source and selection of the most efficient treatment process. Halla Energy & Environment has extensive references for designing, constructing and operating wastewater treatment plants in the areas of pulp materials for paper, livestock manure, waste water from incineration, leachate from landfills and industrial waste water.



Hyundai/Samho industrial wastewater treatment plant (6,500 tons per day)



Hyeongok industrial complex wastewater treatment plant (3,600 tons per day)



Kimpo-Yangchon industrial complex wastewater treatment plant (3,400 tons per day)





Improvement of water purification using smart sensing and operation technology of unit process is the combined maintenance system of which the automatic control system and real time automatic water analysis systems are included.

- Water-monitoring of Taste /Odor using smartsensing
- Operating of advanced oxidation process using real time peroxide measuring device
- Decision making of recycling time using TRRI
- Real time monitoring of disinfection by product in Chlorine disinfection process and Automatic control of Chlorine dosing
- Water-monitoring of water purification by Web-based and the analysis of process efficiency (Smart-EnviDB)



## Improvement of water advanced treatment

By developing the combined maintenance system for purification and maximizing efficiency of advanced water treatment process, we aim at securing treated water quality and establishing simple, economical maintenance. In order to commercialize the integrated operating management system for water advanced treatment and produce & supply qualified tap water, we acquired Certification (NO.605) from the Korean Government. Halla Energy & Environment is concentrating on the existing and the new water purification plants for improvement as well as modernization.

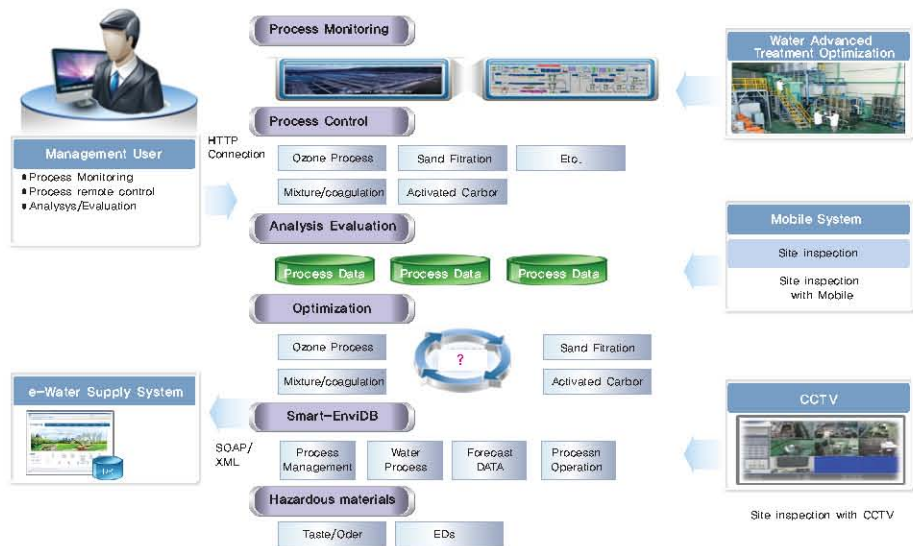
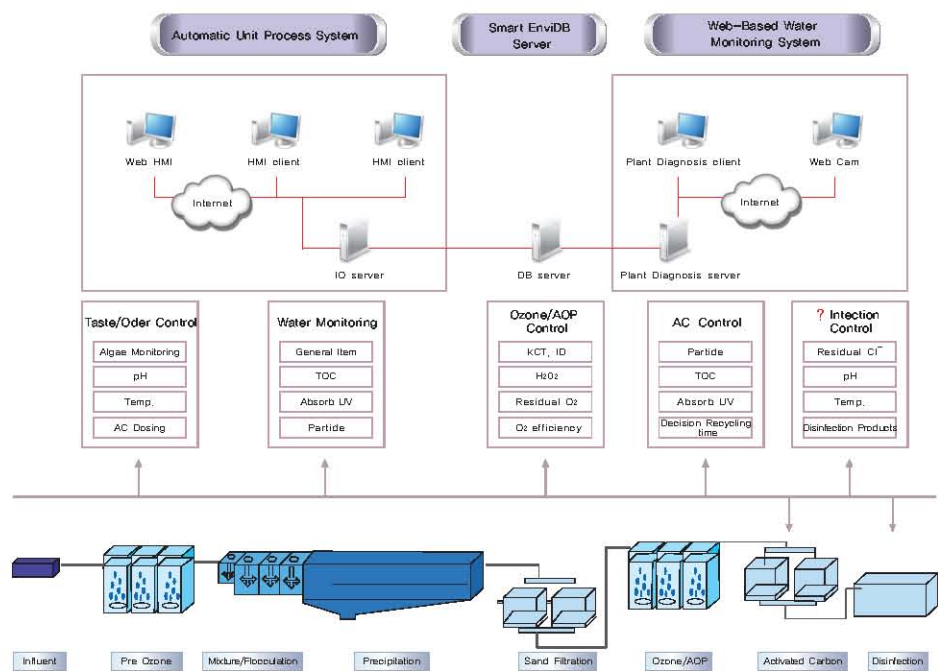



## Riverbed Filtration & Seawater Desalination Intake System

### Benefits of Riverbed Filtration

- Utilizes the natural filtration of the riverbed aquifer
- Removes nutrient salts & pollution substances (Cryptosporidium, DBPs, Endocrine Disruptors)
- Reduced facility site area
- Reduced maintenance cost
- No use of chemicals
- No sludge generated



### Patent

- Title : Water gathering screen having cleaning and reverse cleaning device
- No. : 10-2011-0014343
- Date : 2011.2.18

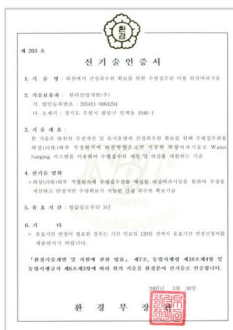

The Riverbed Filtration process extracts water from the river shoreline. The vertical well connected with horizontal(lateral) screen pipes the intakes filtrated river water through the rivered aquifer layer. This process secures an indirect water intake source and helps improve river water quality as well as to maintain river water infiltration.

Furthermore, desalinated seawater, naturally filtrated through the sand beneath the sea water, is gained indirectly by utilizing naturally formed seashore sand. Halla Energy & Environment has modified a beach-well method with high efficiency in operation and management to achieve simple pre-treatment process and reduction of construction and maintenance cost.

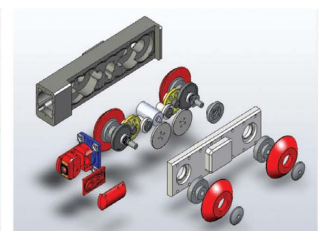
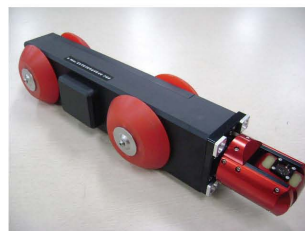
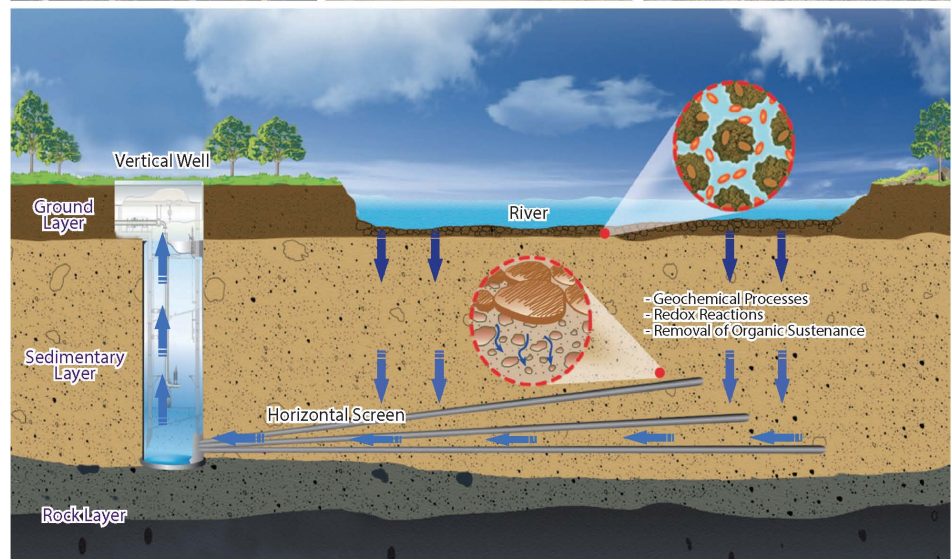



## • Air Pollution Control Facilities

**“Clean Air – Halla Energy & Environment can make it.”**

Clean air for a better life, the air pollution control systems of Halla Energy & Environment are making it possible.

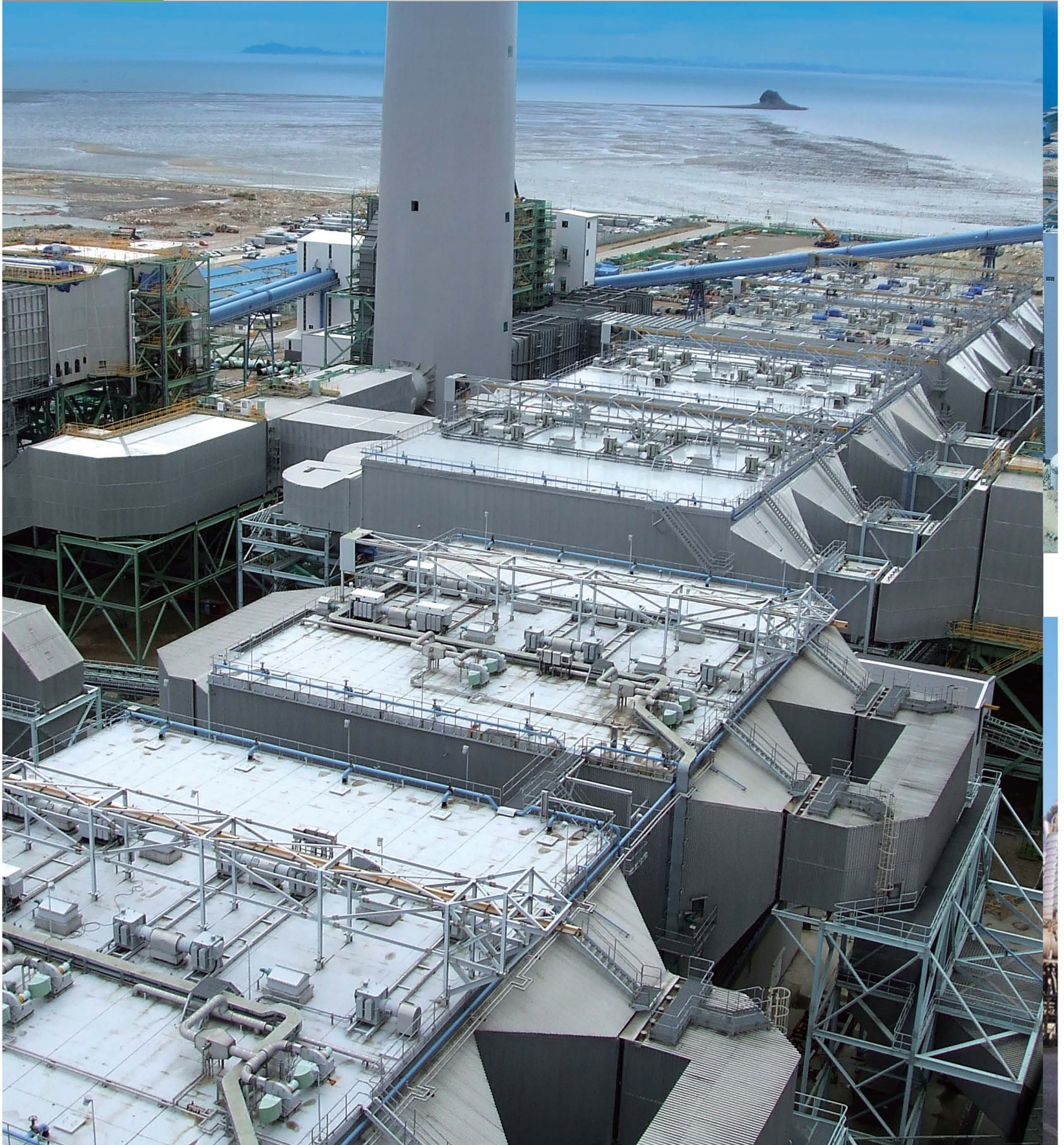



# Precipitators

## Electrostatic Precipitator

The electrostatic precipitator removes dust from emission sources utilizing the principal of corona discharge. Halla's E.P. technology is strictly fulfilling the global dust emission standards as proven by that we supplied the highest efficient Electrostatic Precipitators for Yeongheung thermal power plant 1~4 units in Korea and the Mundra thermal power plant (800MW x 5 lines), the world largest power plant in India.

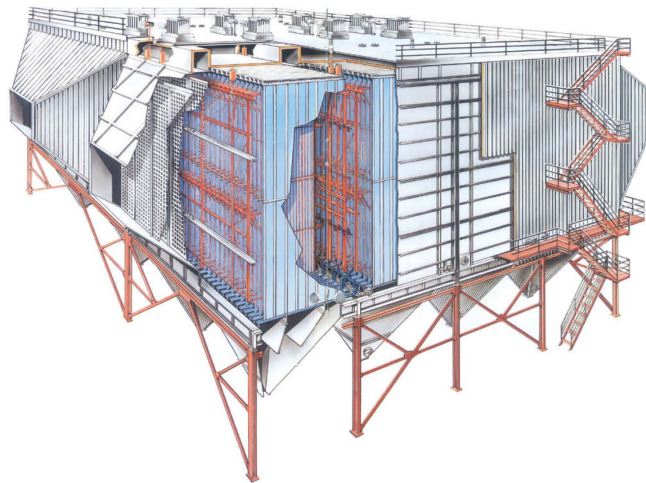

## Fabric Collectors

As environmental standards and regulations for dust emission are getting stricter and stricter, Halla Energy & Environment developed the high efficient fabric collectors by improving the large scale electrostatic precipitators which were mainly used in cement kilns and proven the better performance and results.

Also, our air coolers and fabric collectors of high efficiency that is the pre-treatment facility at the steel mill where the large volume of high-temperature is emitted maintains reputations at all installation sites for its superior performances.



Yeongheung thermal power plant #1&#2 electrostatic precipitators (800MWx2)



Hanbo Steel fabric collector (200 tons per charge)



## Flue Gas Desulfurization System

The flue gas desulfurization (FGD) system removes sulfur oxides present in flue gas produced in boilers and power generation plants utilizing coal or heavy oil as fuel. Halla's FGD system having well-arranged nozzles to spray overlapping in several layers according to the gas flow, has outstanding efficiency in removal of sulfur oxides. Also, Halla FGD offers the advantages of economical initial investment and low operation & maintenance costs as well. High purity gypsum, a by-product, can be used in making gypsum board, an adhesive mixture for cement, an improving agent for soil and as a road paving material.

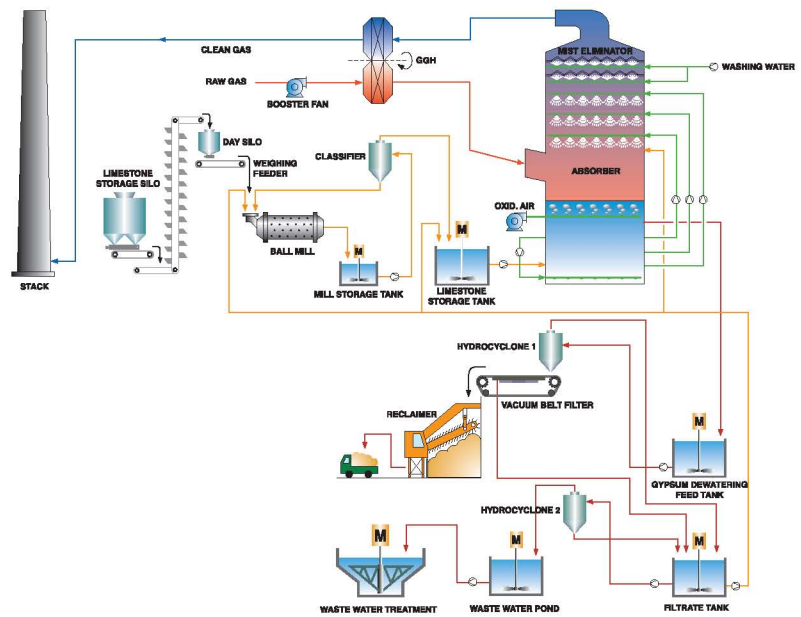

Yeongnam thermal power plant #1 & #2 flue gas desulfurization system (200MWx2)



Absorber



Boryong thermal power plant #7 & #8 flue gas desulfurization system (500MWx2)



## Flue Gas Denitrification System

Halla Energy & Environment is equipped with its own design and supply capacity for selective catalytic reduction (SCR) flue gas denitrification systems. Halla has successfully executed construction of a denitrification system for unit #4 & #5 of the Seoul thermal power plant, the first denitrification facility installed in a thermal power plant in Korea. The selective catalytic reduction (SCR) is the system to decompose nitrogen oxide generated from combustion into harmless nitrogen and vapor before emission to atmosphere by passing the exhaust nitrogen through the catalytic layer along with reductants (ammonia or urea).

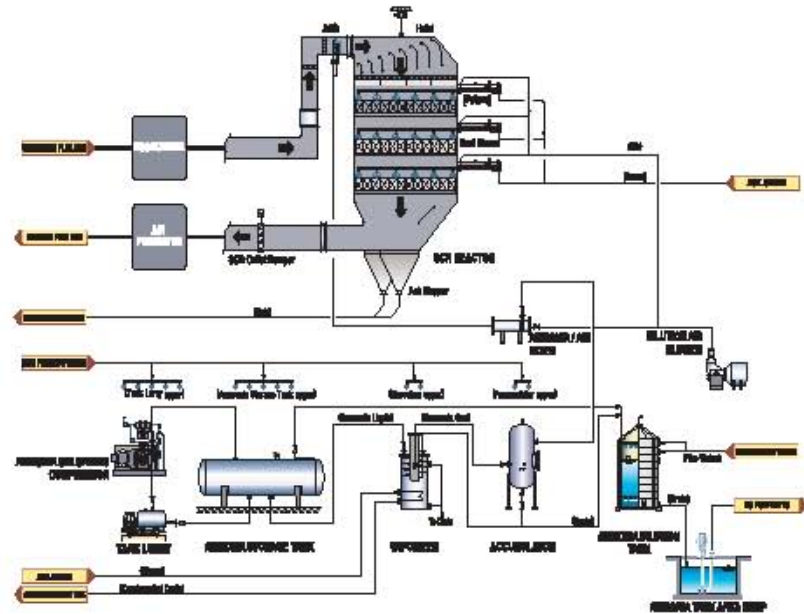

Samcheongpo thermal power plant #3 & #4  
flue gas denitrification system (560MWx2)



Seoul thermal power plant flue gas denitrification system (250MW, 137.5MW)





# Industrial Plants & Equipment

Halla Energy & Environment is proud of being pioneer and successor of industrial plants in Korea.





- **Cement Plants**
- **Material handling,  
Loading & Unloading Equipment**
- **Ash Handling Systems**

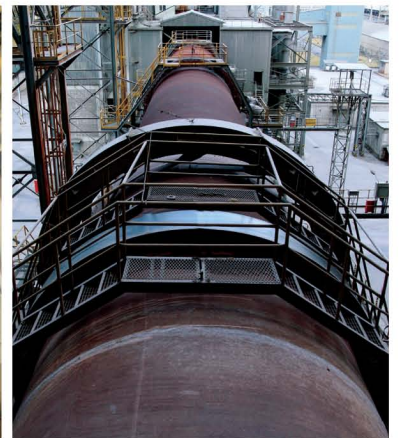
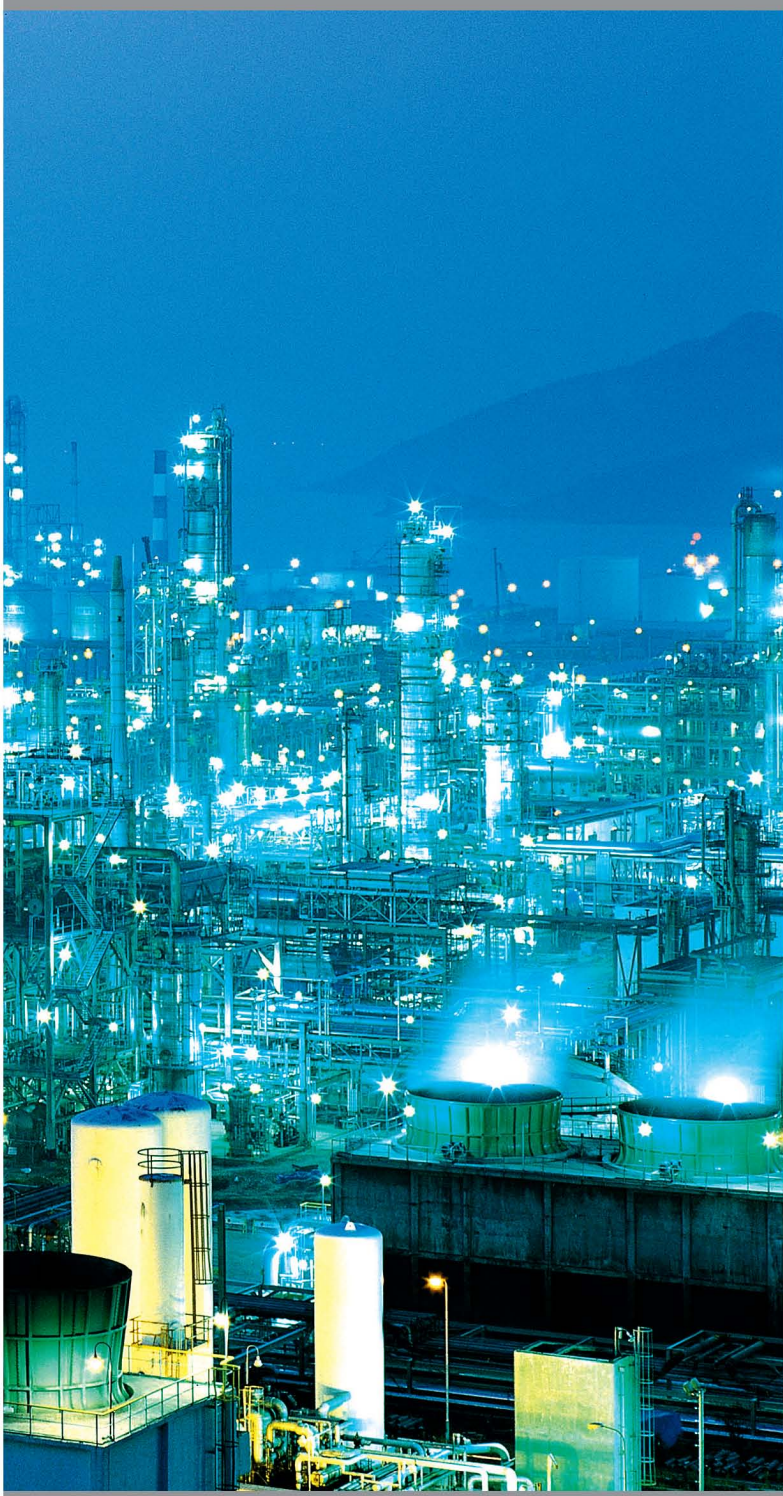



## • Cement Plants

Halla had successfully completed and supplied many large-scale cement plants and production facilities such as Lafarge-Halla Cement and Hyundai Cement project in Korea, SPCC in Saudi Arabia, and NSCC in Malaysia, etc. We have been also engaged in maintenance, renovation and rehabilitation of major cement plants at home and abroad to improve the plants productivity and efficiency.

Lafarge - Halla Cement (7.4 million tons per year)





## • Material handling, Loading & Unloading Equipment



Reclaimer

Based on our advanced technology and abundant production experience of various environmental, industrial and power generation plants and facilities, Halla is also manufacturing the material handling, loading and unloading equipment such as stackers, reclaimers, cranes, conveyors, level-luffing cranes (LLC), unloaders, and advanced automated facilities, etc.



Level Luffing Crane



Ladle Crane

## • Ash Handling Systems



Ash Refinery System

An ash handling system collects and transports the bottom ash and the fly ash generated in coal fired thermal power plants to an ash pond or ash storage silo.

There are two types of bottom ash handling system; wet handling system cooling by water and dry handling system cooling by air.

The fly ash is used as a raw material for cement and an additive mixture for concrete while the bottom ash is recycled into bricks and aggregates as construction materials. Halla's ash handling systems minimize environmental pollution and maximize the economical benefits from the extended recycling.



Ash handling system for the  
Yeongheung Thermal Power Plant (800MW×2)



Submerged Drag Chain Conveyor



Air Lock Feeder





# Energy Plants

The company to create a clean future – Halla Energy & Environment!  
At Halla Energy & Environment, we develop clean energy as we advance the vision of future energy.





- Renewable Energy Facilities
- Power Generation Facilities

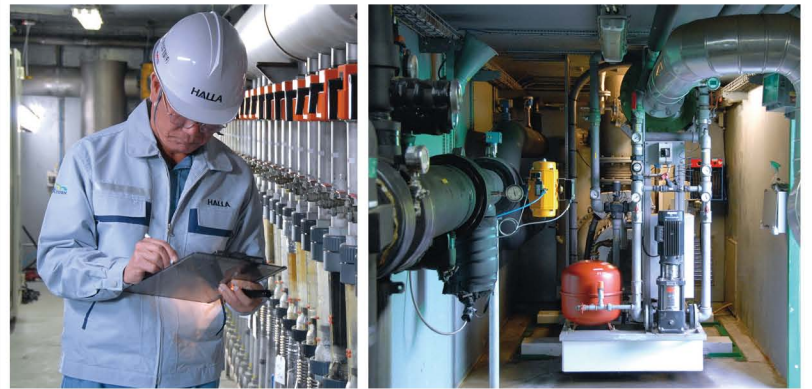



## • Renewable Energy Facilities



Iksan Waste RDF Cogeneration Plant



Wonju RDF Cogeneration Plant

### RDF Cogeneration Plant

RDF (Refuse Derived Fuel) is a solid fuel that is produced by processing combustible components extracted through dehydrating, shredding, and sorting to remove its incombustible matters such as moisture, metal, and glass which are contained in the waste. It utilizes the fluidized bed boiler technology that is designed for combustion of the RDF. Based on the characteristics of fluidized bed boiler which molds well in the layer, it is able to have complete combustion in relatively the low temperature and excess air rate. In addition, fluidized bed boiler adapts to fuels that contain a lot of moisture. The fluidized bed method also has advantage that it is able to reduce pollutant emission without additional process. It produces electric power by using a steam turbine generator with the steam that is produced by combustion of RDF, and the steam with high pressure and high temperature from the steam turbine generator is provided to industrial complex to increase its generation efficiency. Generation by utilizing RDF is an environment friendly energy recovery method that collects the energy from the disposal of waste.

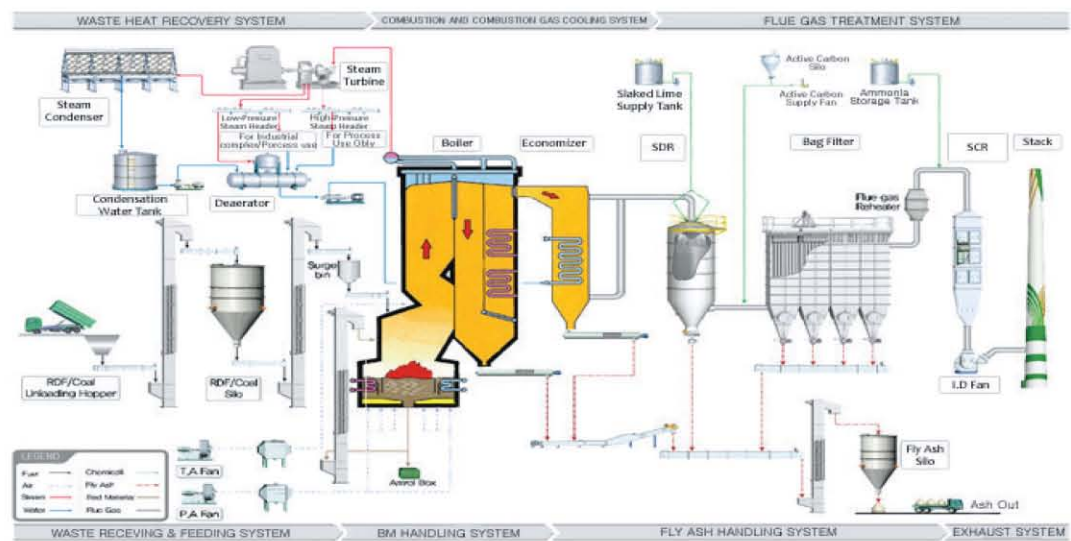

### Waste Heat Recovery Cogeneration for Cement Plant

Cement Waste Heat Recovery Power Generation is a technology for the purpose of effective energy use in recovery of waste heat that is generated during the cement production stage. It produces high pressure steam through the waste heat recovery boiler that uses the high temperature waste heat generated at the cement kiln. The high pressure steam produces the electric power by powering steam turbine and generator. Part of the produced power returns to its generator as the generator's electric power. It provides efficient and economical energy use by making profit through selling back the surplus electric power.

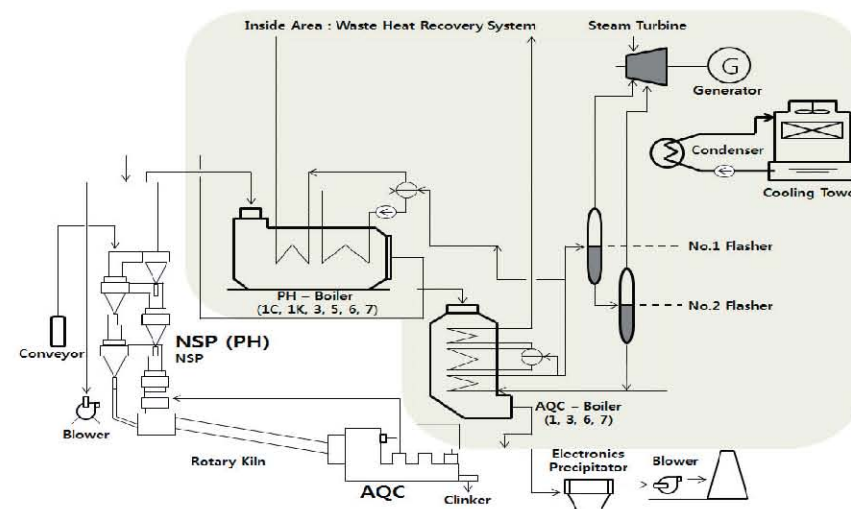





## Biogas Upgrading and Purification Technology

Biogas purification and upgrading technology produces high purity bio-methane through the refinement of biogas that is produced in anaerobic digestion system such as landfills, sewage disposal facilities and organic waste recovery facilities. The high purity bio-methane can be substituted for fossil fuel to be used as automotive fuel. In addition, the technology provides alternative energy, and it leads people to confront climate change more actively. Through the installation and operation of the biogas automotive fuel facility in the Sudokwon landfills site, Halla is producing bio-methane approximately 14,400Nm<sup>3</sup> per day and providing biogas fuel for more than two hundred vehicles per day. Based upon the technology, we are coping with the technological change to recover organic waste such as organic sludge, food waste and waste water. We are striving to provide more CNG fueled vehicles and new & renewable energy by utilizing the technology of biogas automotive fuel.

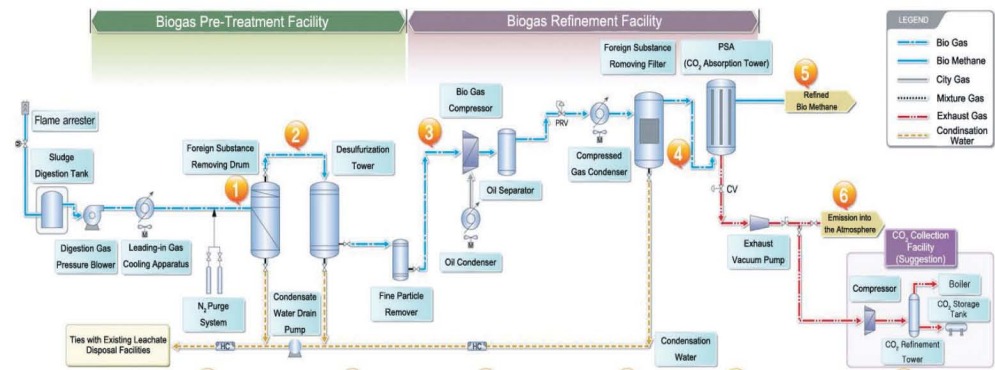

## Landfill Gas (LFG) Recycling Facilities

Converting Landfill Gas (LFG) into industrial fuels such as LNG is accomplished by collecting and purifying methane gas generated from waste landfills. This process not only creates a valuable energy resource but also reduces global warming factors as well as the pungent odors around landfills.

Halla Energy & Environment, for the first time in Korea, secured technology for LFG heavy gas conversion. It has successfully designed and installed conversion units at the Seongam landfill in Ulsan City, where the converted methane is used to increase the SCR temperature at the Ulsan incineration plant and for the boiler at the Keumho Petroleum Chemistry Company. With this project, annual energy savings have amounted to more than 2 Billion Korean Won.

### LFG Supply Facility (Ulsan)

Capacity : 1,300,000 kcal/hr X 3units  
1,500,000 kcal/hr X 3units

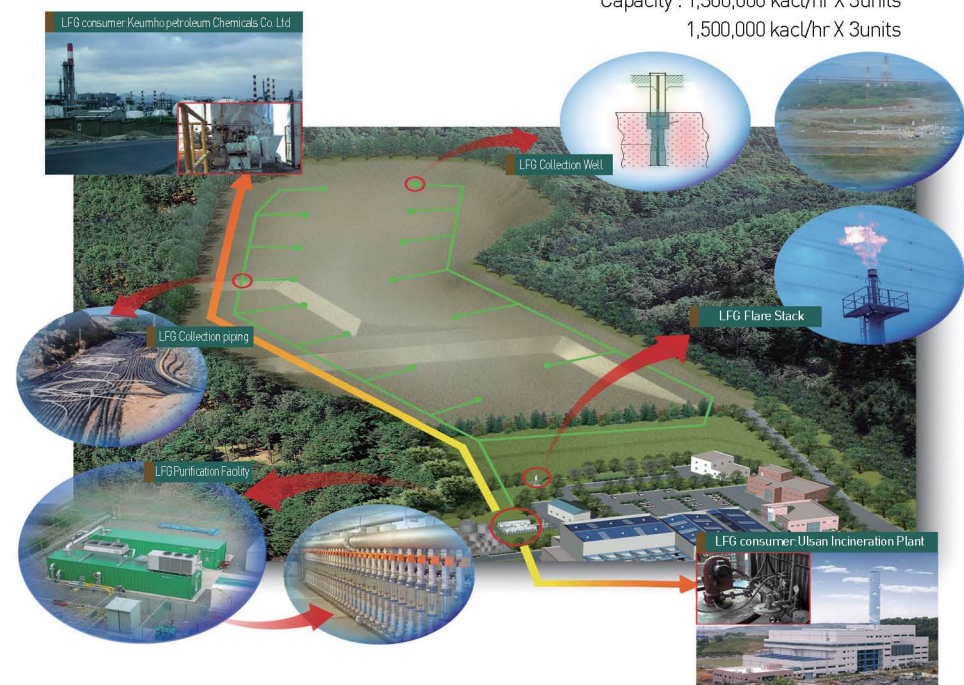



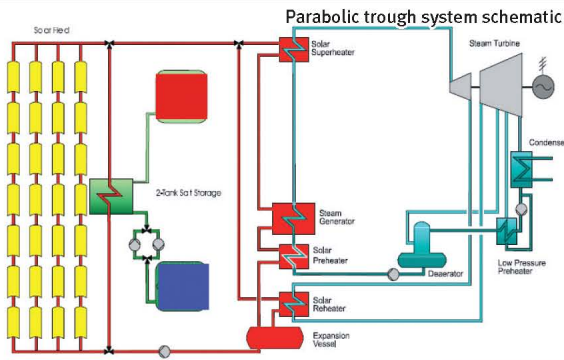

## Concentrated Solar Power Plant (CSP)

Solar power is a clean energy resource for the future that can satisfy all the world's power demand with just 1% of solar radiation from desert regions around the world. Halla Energy & Environment (Halla E&E) has been participating in the Korea-China Collaborative Project, installing 1MW tower type CSP plant developments worthing 15million USD sponsored by the Ministry of Knowledge Economy and the Korea Energy Management Corporation of Korea from Jan. 2006 to Dec. 2011. During the project, Halla E&E and the Korea Institute of Energy Research together was in charge of the key CSP technologies ; the receiver and thermal storage device.

Halla E&E also have participated in Parabolic Dish Stirling System Development Project and studied on the convergence between the CSP and other environmental technologies such as seawater desalination, water detoxification, water disinfection and other methods for waste treatment.

By the effort to successfully commercializing the converged system of CSP and other environmental technologies, Halla E&E now seeks position as an eco-friendly technology company, leading to conserve our global environment.



## Wind Power Plants

Halla Energy & Environment is accelerating R&D for renewable energy resource technologies to cope with environmental changes domestically as well as overseas regarding regulating the discharge of green house gases according to the United Nations Convention on Climate Change.

In meeting with the growing demand of renewable energy in the global market and based on the abundant experience in steel fabrication, Halla expanded its manufacturing plant as its 2<sup>nd</sup> factory in Baria-Vungtau, Vietnam with the latest state of the art facility, the most qualified, experienced man-powers and labors.



## Photo Voltaic Power Plant

During this age of high oil prices and global warming, the world is concentrating efforts to secure a stable supply of energy resources as well as reducing green house gases agreed to in the Kyoto Protocol in Feb. 2005. This is why Halla Energy & Environment is focusing on constructing highly efficient photo voltaic power generation facilities and complexes from site selection to design and construction.





## • Power Generation Facilities

Samcheonpo small hydropower generation facility (1000 KWx6)



### Small Hydropower Plants

Halla Energy & Environment has constructed a small hydropower plant using cooling water discharged from main power generation plants and the difference in the ebb and flow of the tides for the first time in Samchonpo, Korea. With this achievement, we will continue to develop technology and facilities regarding tidal power generation and tidal stream power generation.

### Thermal Power Plants

Meeting with the world's rapidly increasing power generation demands, Halla Energy & Environment is providing power generation facilities in a suitable time based on our extensive accumulated experiences and technologies. Our technology capability and project management in all EPC aspects include design, procurement, construction and commissioning.



### Hydropower Plants

The emphasis on clean power generation facilities has raised the importance of hydropower generation facilities due to the rapid depletion of fossil fuels and the negative impact on the earth's environment. Halla Energy & Environment's experience in hydropower generation facilities includes providing major equipment for the Yongdahm Dam and the integrated monitoring/control system for the Chooncheon hydropower generation facility renovation project.



### Community Energy Supply System (CES)

CES offers energy savings as well as a pleasant environment by simultaneously supplying both heat and steam produced from power generating facilities to apartments, business offices, hotels and department stores located in highly congested areas and to industrial complexes.







# Civil Works and Building Engineering & Construction

Wellbeing Human City – Halla!

Creating environment friendly cities for a clean future – Halla Energy & Environment

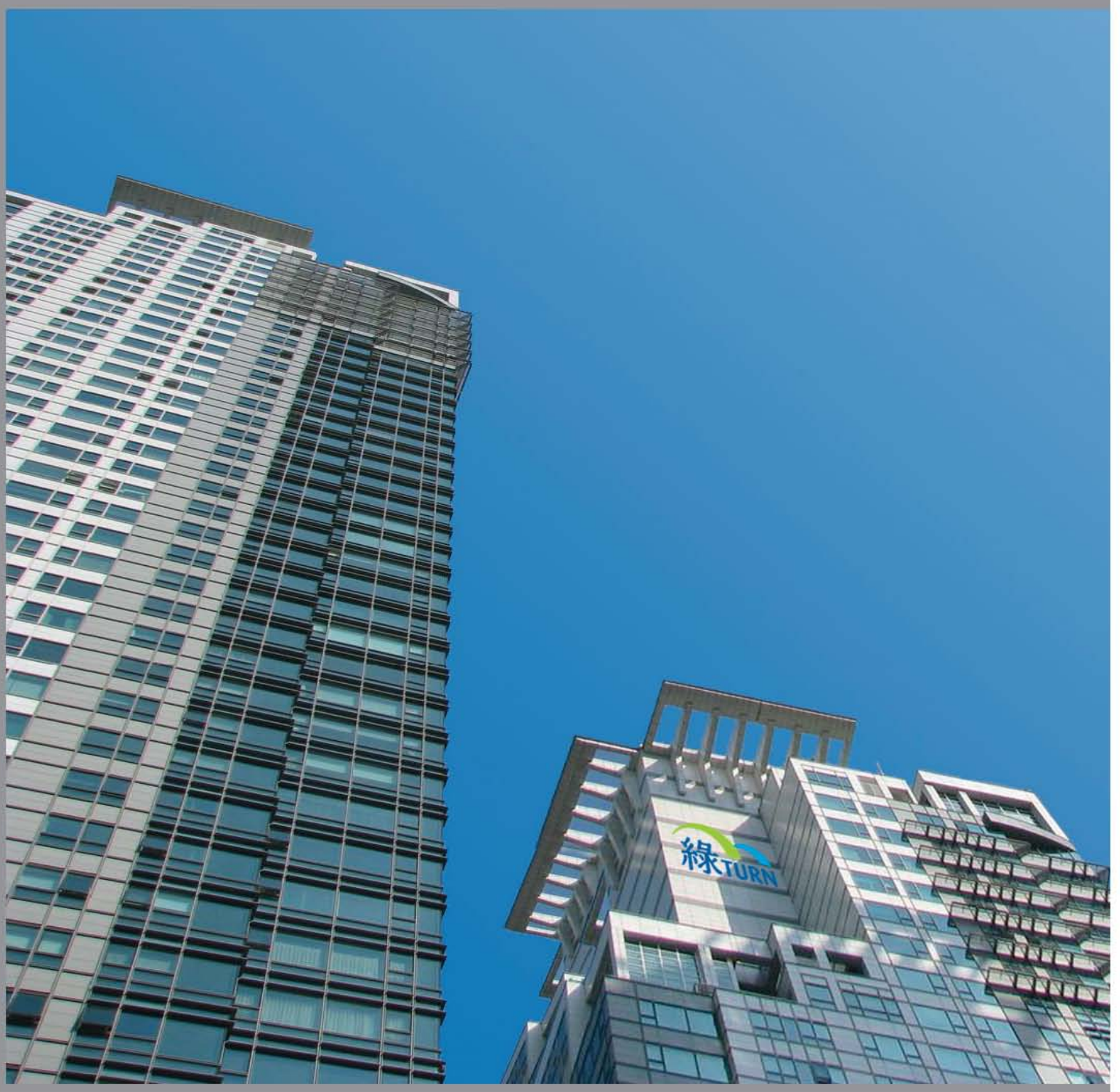



## Roads · Harbors · Apartment renovations & Residential construction

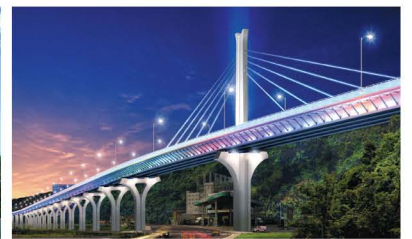
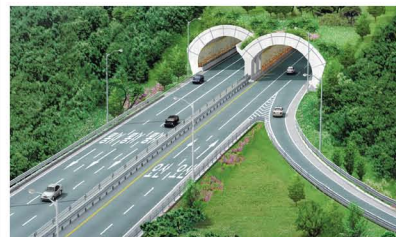
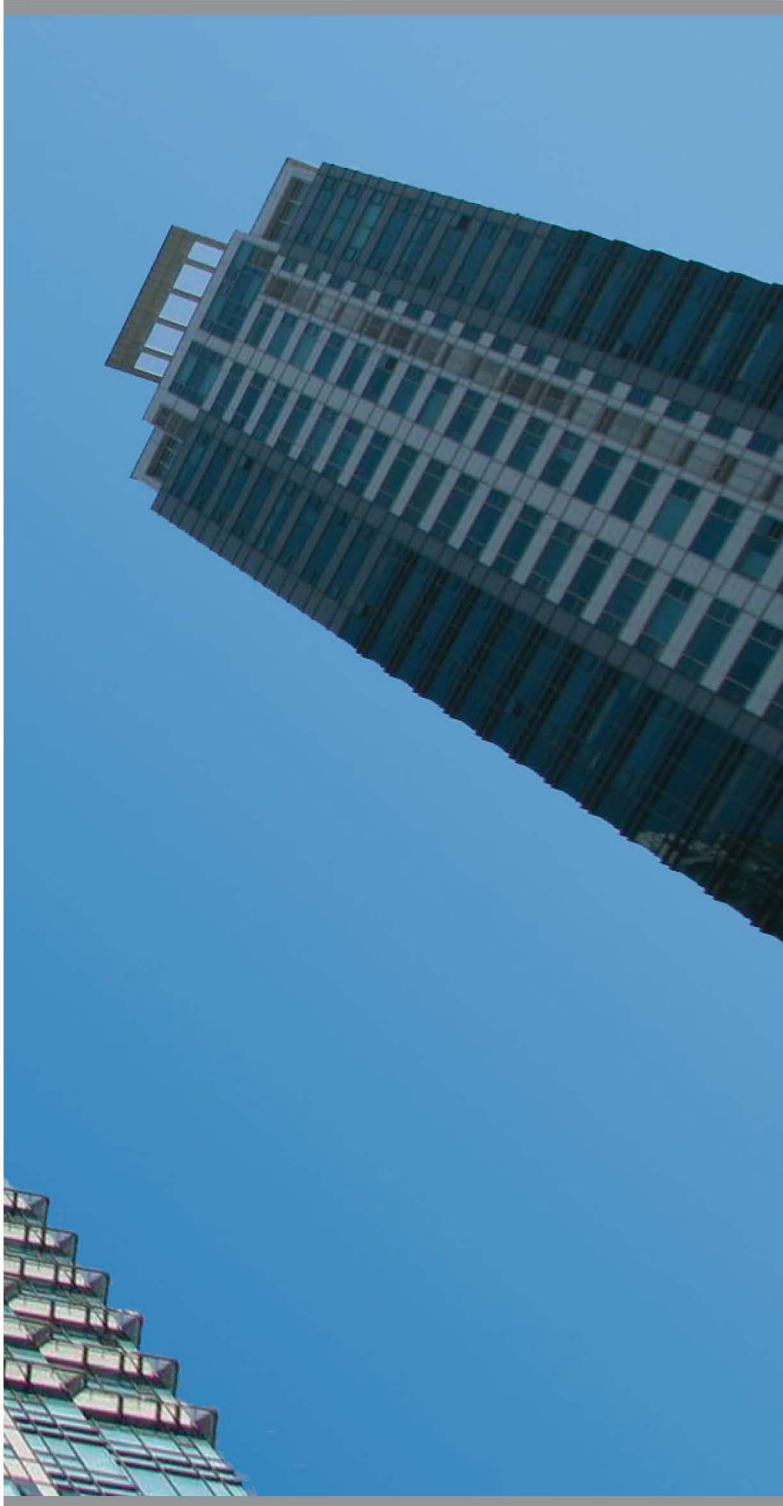



## • Civil Works

Based on our broad construction experiences and technologies, Halla Energy & Environment has made major inroads in the civil works area which is the base for the country's economy including major roads and highways, tunnels, bridges and harbors. From design to construction and after sales service, we have become a company highly respected by our customers.



1. Samho Shipbuilding
2. Taeon Coastal Road
3. Giheung Tunnel
4. Cheongmyeong Tunnel
5. Seocheon Bridge (suspension)

1	2
3	4
5	



## • Building Engineering & Construction

The building engineering and construction area of Halla Energy & Environment is creating pleasant residential and business environments from apartments and business buildings to large-scale area development projects that bring people and nature together in harmony.



1. Pangyo Development Project PF project in Seongnam city
2. International Business Park PF project in Cheonan city
3. Tail Apartment Project in Suwon city
4. Shrimp Farming Center in Ouargla, Algeria
5. Cheongpyeong Condominiums
6. Gunpo Culture Center
7. Incheon Women's Polytechnic High School

		1
		2
3	4	5
	6	7



## Other Business Areas

Wealth knowledge & Knowhow – Halla!  
Only an abundance of experience in operating facilities can guarantee  
low cost operations and stable maintenance.





- **Operation & maintenance of facilities**
- **CDM Projects**
- **Soil Remediation**
- **ESCO Projects**





## • Operation & Maintenance of Facilities

With an abundant experience in designing and constructing environmental plants, Halla Energy & Environment can maintain the stable maintenance of a facility's unique characteristics and maximize advantages thereby. Our know-how obtained from operation of various facilities including incineration plants, sewage water and wastewater treatment plants and food waste treatment plants is resulting in the development of new technologies, improvement of processes and reductions in maintenance costs.



## • CDM Projects

As Halla Energy & Environment is investing more into renewable energy business areas including solar energy, solar heat, wind power, small hydropower facilities, bio energy and landfill gas, we are seeking CDM credit for our projects that are reducing green house gases.

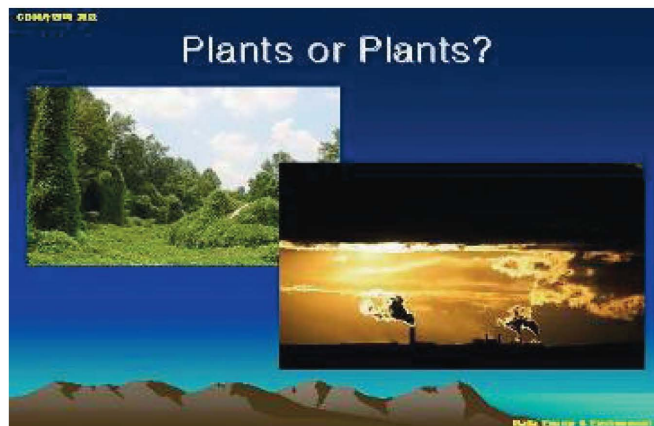



## • Soil Remediation

As a result of increases in population and industrial development such as leachate from landfills, acid drainage from abandoned mines, oil stored underground and substances released from industrial complexes, the Influx of harmful substances is contaminating soil and groundwater sources.

Halla Energy & Environment, on the basis of the environmental technology, accumulated, has acquired patents on groundwater and soil remediation processes developed together with a research team from Seoul National University in order to revive contaminated soil and groundwater sources, a major environmental concern in the 21<sup>st</sup> Century.

The Permeable Reactive Barrier (PRB) is an on-site remediation process that can remove harmful substances such as organic chloride compounds, nutritional salts and heavy metals from the groundwater. We are also making contributions in the development of domestic environmental technologies by participating in the PRB-net, which is an R&D network organized by leading global PRB groups such as the U.S. Environmental Protection Agency, Waterloo University (Canada) and Queen's University (U.K).

Geoworks - a specialized soil remediation company (Joint venture company between Halla Energy & Environment and Seoul National University)

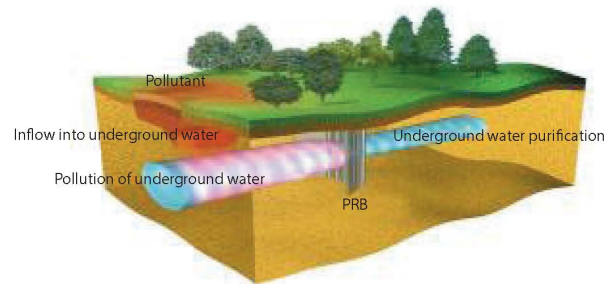
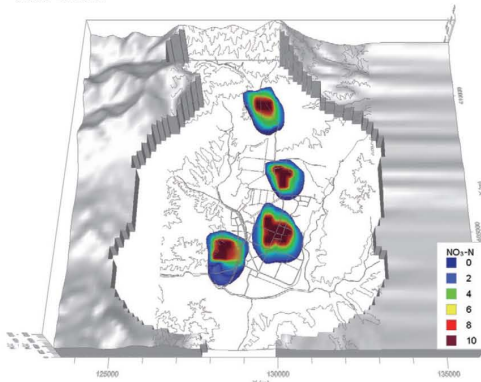

## • ESCO (Energy Service Company)

Halla Energy & Environment is assisting businesses that are involved in developing and converting effective energy generated from manufacturing plants of industries, incinerators, sewage water treatment plants and large buildings into resources through technology development and investment funds.

- ◆ Waste heat retrieval facility for Orion Electrics
- ◆ Haeundae cogeneration facility (electric power production & heat utilization)
- ◆ Gimhae cogeneration facility (electric power production & heat utilization)
- ◆ Waste heat retrieval & fuel conversion facility for Bowater-Halla Paper Corp.



## • Exhaust Gas CO<sub>2</sub> Recovery and Liquefaction Technology

The recovery of exhaust gas CO<sub>2</sub> decreases the emission of gases causing global warming and creates economic added value through storing and selling the liquefied carbonic acid. It satisfies the “Low Carbon Green Growth” industrialization strategy promoted by the government, and the collected CO<sub>2</sub> can be utilized not only in agricultural field as a plant growth catalyst but also in industrial field.

Halla will respond to the nations’ policy such as the energy target scheme through technology development which recovers the exhaust gas CO<sub>2</sub> from its sources such as incineration facilities, environmental plants, chemical plants, power plants, and landfills. The recovered CO<sub>2</sub> will be utilized as agricultural and industrial provision for the acquirement of economic resources.

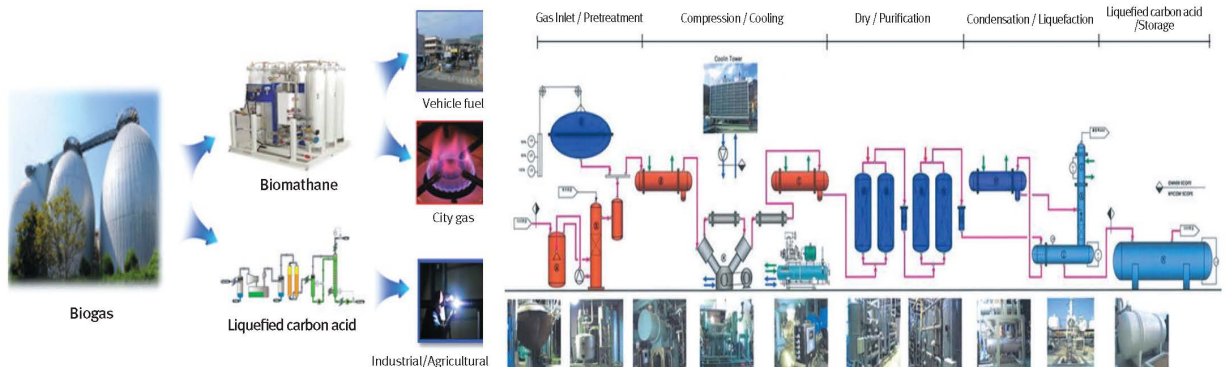



# R&D · Integrated Management System

## Research & Development

Halla Energy & Environment has a strategy for the stronghold in the field of New & Renewable Energy. Based on its accumulated experience in environmental industry Halla Energy & Environment has chosen hydropower, wind power and solar power generation areas, which can substitute fossil fuels, as our new growth engine to reduce carbon dioxide emissions which causes global warming.

Halla Energy & Environment possesses 62 patents and 12 pending patents in the areas of pollution control, waste treatment, water treatment and soil remediation. In addition, we developed riverbed filtration to secure indirect water intake sources which also helps improve river water quality as well as maintain the river water. With these new systems, we acquired the new technology certification from the Korean government. Furthermore, we also acquired a new construction technology for efficient operation on advanced water treatment facilities where each process can be evaluated in real time with a real time monitoring system.



### New Technologies

Field	Division	Approval Certification	Title
Water Treatment	New Environmental Technology	Certification No. 203	The river-bed filtration system with horizontal(lateral) screens for subsurface water intake of a river
	New Construction Technology	Certification No. 605	The Development of Convergence and Optimization Technology for advanced water treatment facilities by real time monitoring and evaluate of each related facilities of performance
	New excellent Technology	Certification No. 386	Diagnosis and Internal Image technique of high tension water pipe(water main) using CCTV robot
Waste Treatment	New Environmental Technology	Certification No. 161	The recycling process of municipal wastes with the stocker purolyzer using the exhaust gas of the melting furnace & char combustion bath-type melting furnace

### Current Status of Patents

Field	Title	Number of Patents		Current Status
		Pending	Registered	
Air pollution Control	Gas sensor		4	
Waste Treatment	Conversion of food waste into resource system		3	
	Incineration system	1	5	
	Sludge treatment system		1	
Water Treatment	ROF system		1	
	Riverbed filtration system	9	8	
	RO system		4	
	Water purification system		2	
	Industrial discharged water recycling system		1	
	CSOs system		1	
	PRS system		4	
	Advanced wastewater treatment system		3	
	Groundwater purification system		4	
	Soil Contamination remediation	PRB system		10
etc.	Rsource recovery of ocean disposal	2	5	
Total		12	62	

## IMS (Integrated Management System)

Halla Energy & Environment, having acquired IMS (Integrated Management System), international certification that integrated ISO9001 (Quality Management), ISO14001 (Environment Management) and OHSAS1800 (Health Safety) for construction and operation business sector for the first time in the construction and environment industry in Korea, is insuring advanced quality management and more systematic and stabilized systems through quality and services that satisfy our customers.

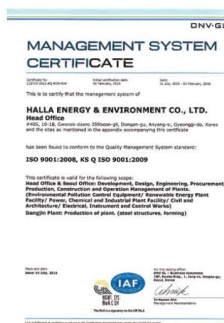



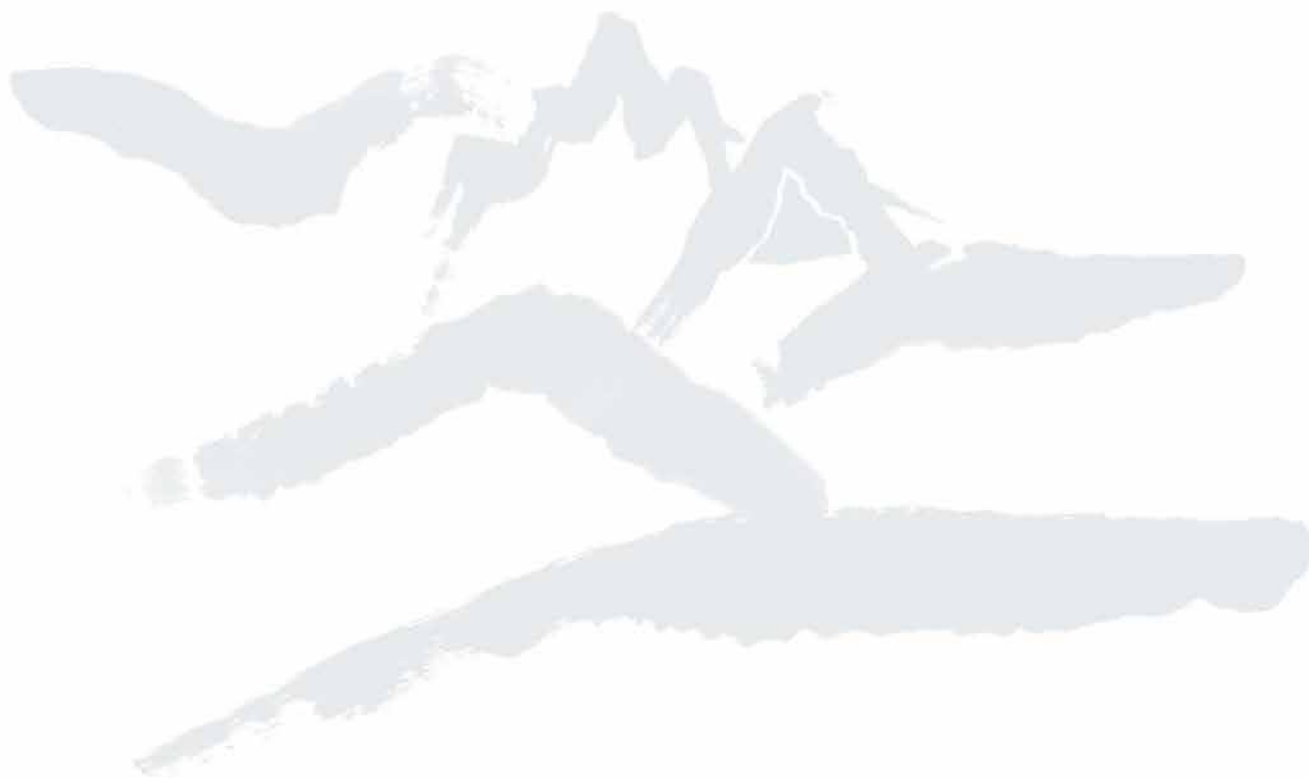

Halla Energy & Environment is making a beautiful harmony between technologies and nature for a brighter and cleaner future.

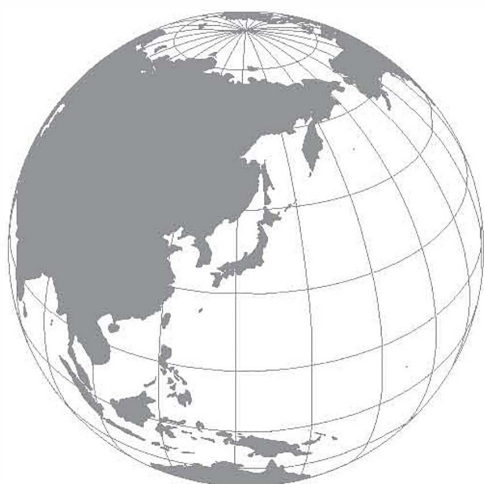

**Headquarter**

5, Byeoryangsangga 3-ro, Gwacheon-si, Gyeonggi-do, Korea

TEL. 82. 31. 233. 5402 FAX. 82. 31. 233. 5404

**Seoul Office**

544, Ogeum-ro, Songpa-gu, Seoul, Korea

TEL. 82. 2. 2047. 5114 FAX. 82. 2. 2047. 5398

**Factory**

464, Seongsan-ro, Godae-myeon, Dangjin-si, Chungcheongnam-do, Korea

TEL. 041. 358. 2227 FAX. 041.358.2226

대표이사: 김기현  
 대표이사: 김기현  
 대표이사: 김기현  
 대표이사: 김기현





**HALLA**  
[www.hallasanup.com](http://www.hallasanup.com)